



# JVC®



## V.NETWORKS

# VN-C2U

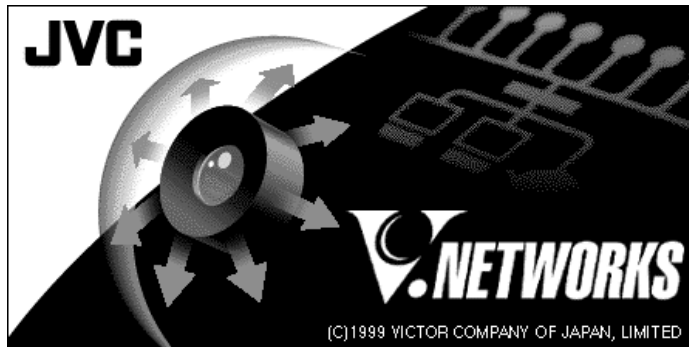

## INSTRUCTIONS

This instruction manual is printed on recycled paper.

Thank you for purchasing the JVC VN-C1U.  
 To gain maximum benefit from this product, read this instruction manual carefully before use and retain it for future reference.  
 The serial number is very important for maintaining quality of your product. At the time of purchase, check to see that the serial number is correctly printed on the top of the unit and that the serial numbers on the unit and warranty match.

### For Customer Use:

Enter below the Model No. and Serial No. which are located on the rear of the cabinet. Retain this information for future reference.

Model No. \_\_\_\_\_

Serial No. \_\_\_\_\_

SS961423-002

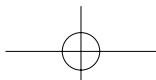

## IMPORTANT SAFEGUARDS

1. Read all of these instructions.
2. Save these instructions for later use.
3. All warnings on the product and in the operating instructions should be adhered to.
4. Unplug this appliance system from the wall outlet before cleaning. Do not use liquid cleaners or aerosol cleaners. Use a damp cloth for cleaning.
5. Do not use attachments not recommended by the appliance manufacturer as they may cause hazards.
6. Do not use this appliance near water – for example, near a bathtub, washbowl, kitchen sink, or laundry tub, in a wet basement, or near a swimming pool, etc.
7. Do not place this appliance on an unstable cart, stand, or table. The appliance may fall, causing serious injury to a child or adult, and serious damage to the appliance.

PORTABLE CART WARNING  
(symbol provided by RETAC)



S3126A

Use only with a cart or stand recommended by the manufacturer, or sold with the appliance. Wall or shelf mounting should follow the manufacturer's instructions, and should use a mounting kit approved by the manufacturer.

An appliance and cart combination should be moved with care. Quick stops, excessive force, and uneven surfaces may cause the appliance and cart combination to overturn.

8. Slots and openings in the cabinet and the back or bottom are provided for ventilation, and to insure reliable operation of the appliance and to protect it from overheating, these openings must not be blocked or covered. The openings should never be blocked by placing the appliance on a bed, sofa, rug, or other similar surface. This appliance should never be placed near or over a radiator or heat register. This appliance should not be placed in a built-in installation such as a bookcase unless proper ventilation is provided.
9. This appliance should be operated only from the type of power source indicated on the marking label. If you are not sure of the type of power supplied to your home, consult your dealer or local power company. For appliance designed to operate from battery power, refer to the operating instructions.
10. This appliance system is equipped with a 3-wire grounding type plug (a plug having a third (grounding) pin). This plug will only fit into a grounding-type power outlet. This is a safety feature. If you are unable to insert the plug into the outlet, contact your electrician to replace your obsolete outlet. Do not defeat the safety purpose of the grounding plug.



11. For added protection for this product during a lightning storm, or when it is left unattended and unused for long periods of time, unplug it from the wall outlet and disconnect the antenna or cable system. This will prevent damage to the product due to lightning and power-line surges.
12. Do not allow anything to rest on the power cord. Do not locate this appliance where the cord will be abused by persons walking on it.
13. Follow all warnings and instructions marked on the appliance.
14. Do not overload wall outlets and extension cords as this can result in fire or electric shock.
15. Never push objects of any kind into this appliance through cabinet slots as they may touch dangerous voltage points or short out parts that could result in a fire or electric shock. Never spill liquid of any kind on the appliance.
16. Do not attempt to service this appliance yourself as opening or removing covers may expose you to dangerous voltage or other hazards. Refer all servicing to qualified service personnel.
17. Unplug this appliance from the wall outlet and refer servicing to qualified service personnel under the following conditions:
  - a. When the power cord or plug is damaged or frayed.
  - b. If liquid has been spilled into the appliance.
  - c. If the appliance has been exposed to rain or water.
  - d. If the appliance does not operate normally by following the operating instructions. Adjust only those controls that are covered by the operating instructions as improper adjustment of other controls may result in damage and will often require extensive work by a qualified technician to restore the appliance to normal operation.
  - e. If the appliance has been dropped or the cabinet has been damaged.
  - f. When the appliance exhibits a distinct change in performance – this indicates a need for service.
18. When replacement parts are required, be sure the service technician has used replacement parts specified by the manufacturer that have the same characteristics as the original part. Unauthorized substitutions may result in fire, electric shock, or other hazards.
19. Upon completion of any service or repairs to this appliance, ask the service technician to perform routine safety checks to determine that the appliance is in safe operating condition.

**JVC**<sup>®</sup>  
VICTOR COMPANY OF JAPAN, LIMITED

 Printed in Japan

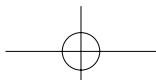

## IMPORTANT SAFEGUARDS

1. Read all of these instructions.
2. Save these instructions for later use.
3. All warnings on the product and in the operating instructions should be adhered to.
4. Unplug this appliance system from the wall outlet before cleaning. Do not use liquid cleaners or aerosol cleaners. Use a damp cloth for cleaning.
5. Do not use attachments not recommended by the appliance manufacturer as they may cause hazards.
6. Do not use this appliance near water – for example, near a bathtub, washbowl, kitchen sink, or laundry tub, in a wet basement, or near a swimming pool, etc.
7. Do not place this appliance on an unstable cart, stand, or table. The appliance may fall, causing serious injury to a child or adult, and serious damage to the appliance.

PORTABLE CART WARNING  
(symbol provided by RETAC)



S3126A

Use only with a cart or stand recommended by the manufacturer, or sold with the appliance. Wall or shelf mounting should follow the manufacturer's instructions, and should use a mounting kit approved by the manufacturer.

An appliance and cart combination should be moved with care. Quick stops, excessive force, and uneven surfaces may cause the appliance and cart combination to overturn.

8. Slots and openings in the cabinet and the back or bottom are provided for ventilation, and to insure reliable operation of the appliance and to protect it from overheating, these openings must not be blocked or covered. The openings should never be blocked by placing the appliance on a bed, sofa, rug, or other similar surface. This appliance should never be placed near or over a radiator or heat register. This appliance should not be placed in a built-in installation such as a bookcase unless proper ventilation is provided.
9. This appliance should be operated only from the type of power source indicated on the marking label. If you are not sure of the type of power supplied to your home, consult your dealer or local power company. For appliance designed to operate from battery power, refer to the operating instructions.
10. This appliance system is equipped with a 3-wire grounding type plug (a plug having a third (grounding) pin). This plug will only fit into a grounding-type power outlet. This is a safety feature. If you are unable to insert the plug into the outlet, contact your electrician to replace your obsolete outlet. Do not defeat the safety purpose of the grounding plug.



11. For added protection for this product during a lightning storm, or when it is left unattended and unused for long periods of time, unplug it from the wall outlet and disconnect the antenna or cable system. This will prevent damage to the product due to lightning and power-line surges.
12. Do not allow anything to rest on the power cord. Do not locate this appliance where the cord will be abused by persons walking on it.
13. Follow all warnings and instructions marked on the appliance.
14. Do not overload wall outlets and extension cords as this can result in fire or electric shock.
15. Never push objects of any kind into this appliance through cabinet slots as they may touch dangerous voltage points or short out parts that could result in a fire or electric shock. Never spill liquid of any kind on the appliance.
16. Do not attempt to service this appliance yourself as opening or removing covers may expose you to dangerous voltage or other hazards. Refer all servicing to qualified service personnel.
17. Unplug this appliance from the wall outlet and refer servicing to qualified service personnel under the following conditions:
  - a. When the power cord or plug is damaged or frayed.
  - b. If liquid has been spilled into the appliance.
  - c. If the appliance has been exposed to rain or water.
  - d. If the appliance does not operate normally by following the operating instructions. Adjust only those controls that are covered by the operating instructions as improper adjustment of other controls may result in damage and will often require extensive work by a qualified technician to restore the appliance to normal operation.
  - e. If the appliance has been dropped or the cabinet has been damaged.
  - f. When the appliance exhibits a distinct change in performance – this indicates a need for service.
18. When replacement parts are required, be sure the service technician has used replacement parts specified by the manufacturer that have the same characteristics as the original part. Unauthorized substitutions may result in fire, electric shock, or other hazards.
19. Upon completion of any service or repairs to this appliance, ask the service technician to perform routine safety checks to determine that the appliance is in safe operating condition.

**JVC**<sup>®</sup>  
VICTOR COMPANY OF JAPAN, LIMITED

 Printed in Japan

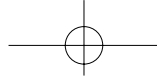

## Package Contents

This product is packaged with the following items. Contact your dealer of purchase for any missing items.

- VN-C2U main unit
- VN-C2U controller CD-ROM
- Ferrite core
- Instruction manual (this document)



## Operational Environment

The following environment is necessary for the operation of VN-C2U.

### PC operating with Microsoft Windows 95,98 or NT

CPU	:	Pentium 133MHz or equivalent or higher (200MHz or higher recommended)
Memory	:	32MB or more (64MB or more recommended)
Hard disk space	:	20MB or more
Display and video card	:	640 X 480 pixels or higher; high color (1024 X 768 pixels or higher; true color recommended)
10BASE-T	:	LAN board, connector cables

### LAN environment

10BASE-T network cross-connected with HUB, etc. of IEEE802.3 standard.

It is also possible to connect your PC with VN-C2U directly (1:1) using a crossing cable (please check since some LAN boards do not allow use of cross cables).



## Precautionary Notes

- **Avoid installing in the following locations:**
  - Where the unit is exposed to rain or water
  - Where the ambient temperature exceeds the range of 0°C ~ +40°C (recommended)
  - Where there is vibration
  - Dusty areas or areas with oil or gas
- **The sensitivity will automatically increase when using this unit in a dark location with the AGC on (Full Auto on). At this time the screen may appear rough; however this is not a malfunction.**
- **When using Full Auto on for the white balance of this unit, the tint may appear slightly different from that of the actual color due to the principle of the automatic white balance tracking circuit; however, this is not a malfunction.**
- **When shooting a highly bright object such as lamps, etc. white tails may appear above and below the object on the screen. This is an elemental characteristic seen when shooting solid objects referred to as the smearing effect, and is not a malfunction.**



## About Upgrades

Upgrades of the software (VN-C2U) can be obtained via the Internet. The upgrade software can be downloaded from the following homepage:  
<http://www.jvc-victor.co.jp>



# Installation and Setup

## Before starting installation and setup

Since a setup of one IP address is necessary for each VN-C2U, follow the procedure given below to setup each unit (the installation can be made at the same time if the power is left off).

### 1. Install VN-C2U

※ When installing in a location where it is difficult to turn the power on and off, install after completing steps 2 through 5.

### 2. Connect VN-C2U to a network

(turn the power of VN-C2U on)

### 3. Set the IP address of VN-C2U

※ Always contact the network management for the IP address of VN-C2U and use only that which is assigned or authorized. For setup of a second unit and following, reboot the PC and return to step 2.

### 4. Enable the set IP address of VN-C2U

(Turn the power of VN-C2U off once, then turn the power back on)

### 5. Register the connecting point

※ Register the IP address information of VN-C2U to the user PC.

## Names of VN-C2U parts

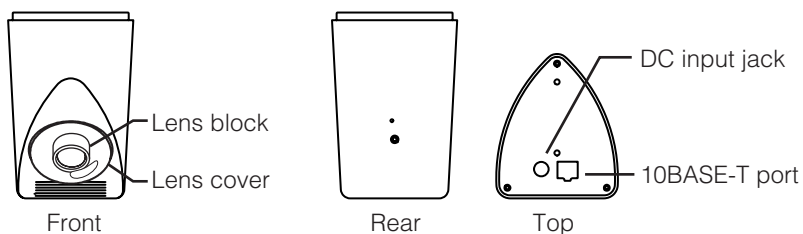





## Installation and Setup

### 1. Installation

Install using the separately sold mounting kit (model no. VN-BK20).

Do not turn the power on or connect to a network until installation is completed.

#### Note

To prevent the unit from falling, mount only on areas with sufficient strength. VN-C2U can be installed as shown in the diagram below, or inverted. Do not install the unit sideways.

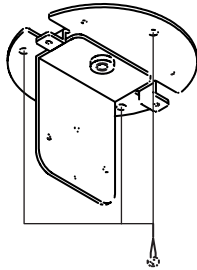

(1) Mount the bracket onto the ceiling, etc.

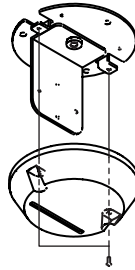

(2) Mount the cover on the bracket

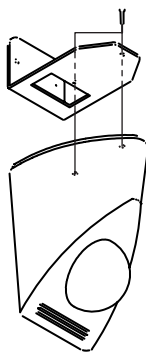

(3) Mount VN-C2U on the bracket



## 2. Connecting to a network

Turn on the power of only one VN-C2U.

Connecting VN-C2U to a network and turning on the power will connect the unit to a network with the following IP address.

Factory set IP address : 192.168. 1. 2

To retain electromagnetic compatibility, use the provided ferrite core when connecting to VN-C2U.

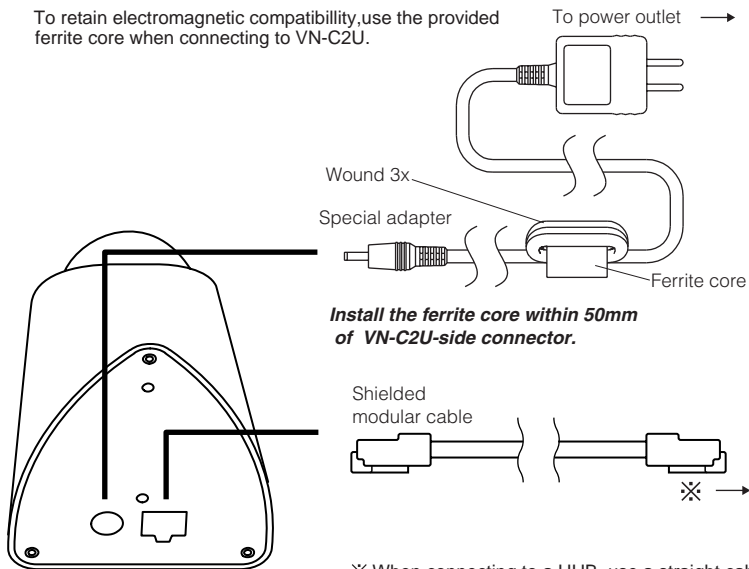

※ When connecting to a HUB, use a straight cable.  
When connecting directly to a PC, use a crossing cable.

### Note

All VN-C2U at the time of shipment have the same IP address. Correct access cannot be obtained when turning the power of multiple units on at the same time due to overlap of ID addresses. Always turn on the power of one unit at a time and proceed with the following VN-C2U IP address setup. In the case where doubling of IP addresses occur, correct access may not be achieved unless waiting for at least 10 minutes after making correction, or turning off all network devices then turning them back on.

### 3. VN-C2U IP address setup

#### 3-1 Changing the IP address of the PC making the setting

From the [Start] button proceed to [Setup] - [Control Panel] - [Network] to display the network setup panel.

The image shows two screenshots from a Windows operating system. The top screenshot is the 'Network' control panel window, with the 'Configuration' tab selected. It lists installed network components: 'Client for Microsoft Networks', 'TCP/IP', and 'File and printer sharing for Microsoft Networks'. The 'Properties' button for 'TCP/IP' is highlighted with a callout box. Below this, the 'Primary Network Logon' is set to 'Client for Microsoft Networks' and 'File and Print Sharing...' is checked. The 'Description' field states: 'TCP/IP is the protocol you use to connect to the Internet and wide-area networks.' The 'OK' button is also highlighted with a callout box.

The bottom screenshot is the 'TCP/IP Properties' dialog box. The 'IP Address' field is set to '192.168.1.1' and the 'Subnet Mask' field is set to '255.255.255.0'. The 'Specify an IP address' radio button is selected. A callout box points to these fields with instructions. The 'OK' button is highlighted with another callout box.

(1) Select TCP/IP and click Properties.

(2) **Before making changes, take note of the original IP address.**  
After taking note of the IP address, change it to:192.168. 1. 1

(3) Set appropriate values for the Subnet Mask during the setting. If unknown, contact your network management.

(4) After clicking OK, reboot the PC.



### 3-2 Installing the software

Insert the VN-C2U controller CD-ROM into the CD-ROM drive.

The setup program is located in the \JVC folder of the CD-ROM.

Execute **\JVC\Setup.exe**, then follow the on-screen guidance to setup the software.

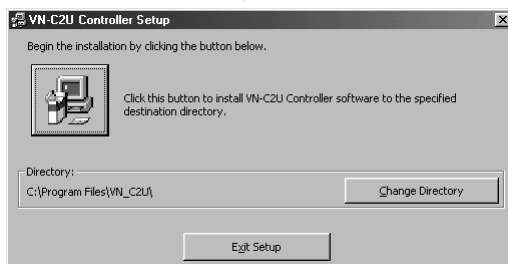

### 3-3 VN-C2U IP address setup

The V.NETWORKS setup tool is located in the \JVC\setup folder of the CD-ROM.  
Execute \JVC\setup\setup.exe (execute directly from the CD-ROM).

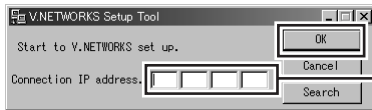

Input the IP address of VN-C2U being set.  
Factory set IP address is 192.168. 1. 2.

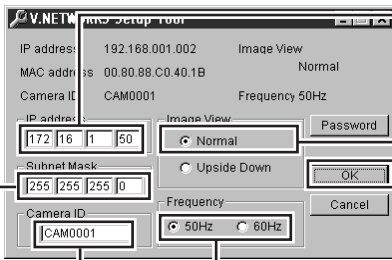

Input the IP address assigned or authorized by the network management.  
(The illustration shows an example using 172.16. 1. 50.)

Depending on the installation condition, select either Normal installation (JVC mark on VN-C2U is upright) or Inverted installation (if uncertain due to a special installation, select Normal)

Setting to reduce flickering under fluorescent lighting.  
Specify 50Hz or 60Hz, depending on the power supply frequency of the installed location.

The Camera ID is equivalent to the ID code of the VN-C2U main unit. Input using alphanumerics. This setting does not directly concern users.  
Normally this ID is set by numbering up.

Set appropriate values for the sub-net mask during the setting. If unknown, contact your network management.

※ For an explanation of the password button, see the following page.



**Password protection feature**

VN-C2U is equipped with an access protection feature using a password to regulate connecting PCs (users).

This password can be set or canceled using the V.NETWORKS setup tool.

**Note**

Never forget the password since the password setting can only be changed and canceled when the current password matches.

The following screen will appear when clicking the Password button of the V.NETWORKS setup tool.

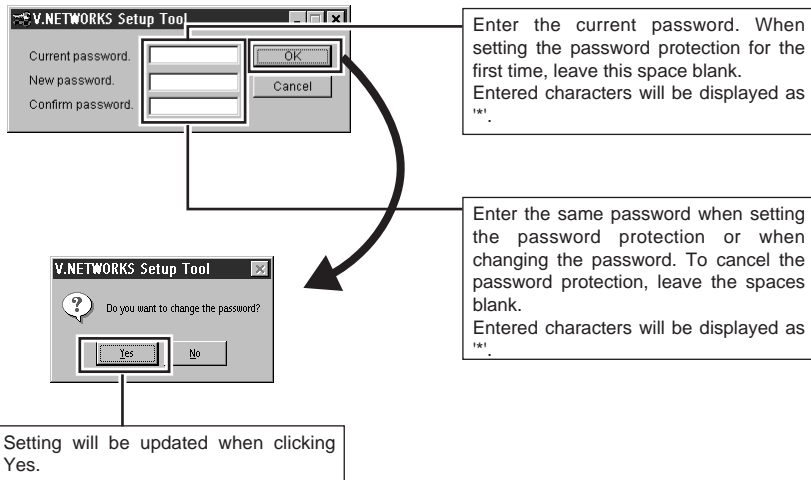

The following Password Request screen will appear for VN-C2U set with password protection. VN-C2U setup cannot be made unless the password matches.

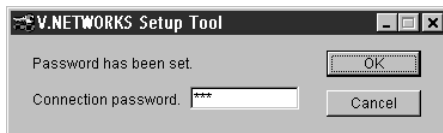

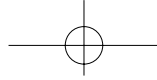

#### Notes

The V.NETWORKS setup tool will only operate on PCs installed using the procedure described on page 7 (execution of setup.exe). The setup tool will not operate properly if setup.exe has not been executed. For PCs that have executed setup.exe can also operate the setup tool by copying the setup folder to the hard disk, etc. The V.NETWORKS setup tool is a software that is used only when setting up. In case the folder is copied, we asked that it be deleted after completion of the setup, unless the PC requires the folder for a special reason.

For setup of a second unit and following, reboot the PC and return to step 2 (page 5). Proceed when all VN-C2U settings are completed.

#### 3-4 Restoring the IP address of the work PC

In the same manner as 3-1, start from the [Start] button then go [Setup]-[Control Panel]-[Network], then correct/restore the TCP/IP properties of the network settings to the original **IP address** which was noted.

After correction, reboot the PC according to the on-screen instructions.

#### 4. Enabling the set IP address

Turn the power of VN-C2U off, then turn the power back on.

(The pan/tilt mechanisms will reset when the power is turned on. This reset operation can be used to check that the unit is operating normally.)

※The IP address changed using the setup tool is enabled for the first time when the power of VN-C2U is turned off, then turned backed on.

(The unit will continue operation using the IP address before the change until the power is turned off.)

#### [ IP ADDRESS SEARCH FUNCTION]

By pressing the "Search" button, you can view the IP address of V.NETWORKS now connected to the network. Pressing the search button brings up the [search screen] window.

By pressing "Search" on the [search screen] window, a list of IP address of all V.NETWORKS is displayed. Using TIME-OUT, you can set the time for search from 0 to 30 seconds.

## 5. Registering the connection point

Start up the VN-C2U controller (VN-C2U connection software: vn-c2u.exe).

Execute [Create New] from the [File] menu to set the connection point.

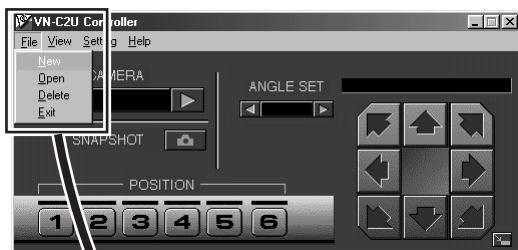

Enter the VN-C2U IP address of the connection point and the setting name (the illustration shows an example using 172. 16. 1. 50).

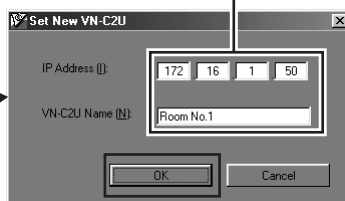

※ To make correction after completing registration, first delete all settings then re-register.

### **Advice**

#### **To copy connection point settings to another PC**

The VN-C2U connection point information is created as a dat file (extension: .dat) in the folder where the connection software was installed.

Connection point information can easily be copied to another PC by copying the dat file.





## Operating the Controller Software

### Establishing Connection and changing the connection point

For the installation procedure, see page 7 Installing the software. When the VN-C2U controller: vn-c2u.exe is started up, a splash logo will appear, followed by the following screen.

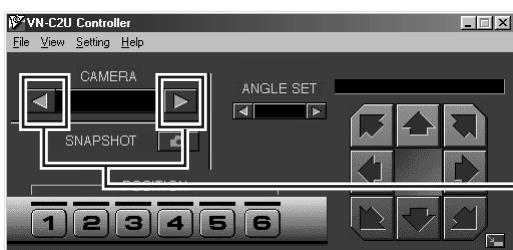

Clicking one of the buttons will establish connection with the registered connection point.

Connection can also be made using the following procedure.



Select [Open] from the [File] menu.

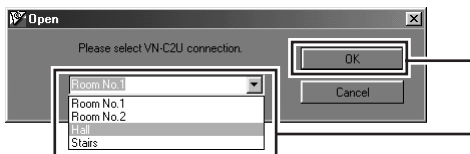

Select the connection point, then click the OK button.



## Controller 1

The VN-C2U screen will immediately appear when connection is established. The currently connected VN-C2U name, angle steps of the pan/tilt, and pan/tilt positions will be displayed.



The connected VN-C2U angle steps of the pan/tilt can be changed using the right and left arrow buttons (⏪ and ⏩).  
 The pan/tilt positions are changed using the 8 pan/tilt buttons.  
 The operating angle of the pan/tilt button when pressed one time is set using the angle steps.

**The pan/tilt position display is as shown in the illustration.**

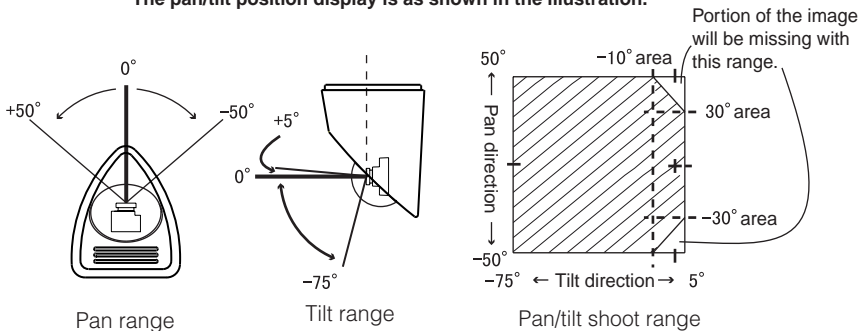



## Controller 2

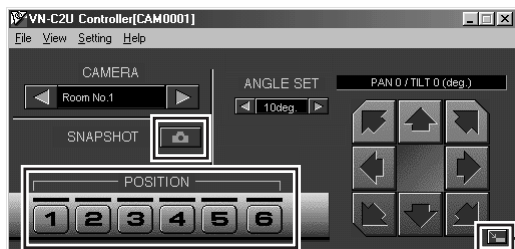

The VN-C2U controller is equipped with a feature to save 1 frame of the images from the connected VN-C2U as a still image. The currently displayed VN-C2U image can be saved by clicking this button. For details, see page 20 Still image save feature

The VN-C2U main unit is equipped with 6 position memories. The positions of the connected VN-C2U can be changed by clicking these buttons. For details on changing the position memory contents, see page 19 Changing the position memory.

In case the VN-C2U controller screen is too large to fit in the screen, click here to reduce the controller size. Clicking this button will switch the screen alternately between large and small.

## Controller (small)

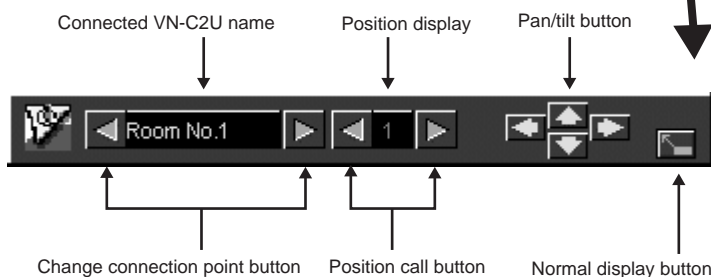



## Controller 3

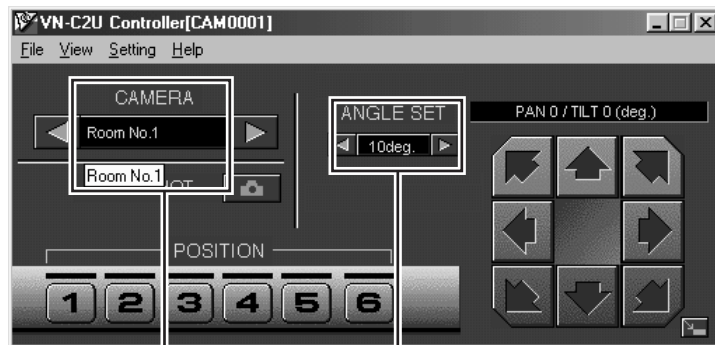

Placing the mouse pointer on the VN-C2U and waiting momentarily will display the VN-C2U name in a form of a balloon display. The entire VN-C2U name will appear in the balloon display, even for long names.

The angle steps can be directly inputted by clicking the mouse on the angle step display. To change, input a numerical value, then press the Enter key.

## Creating a new connection point

See page 11 Registering a connection point



## Deleting a connection point

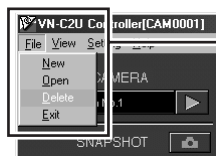

Select [Delete] from the [File] menu.

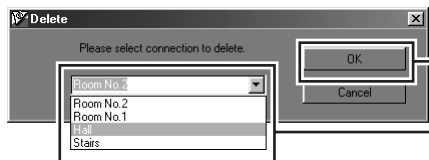

Select the connection point, then click OK.



Check the content to delete, then click OK.

**Note**  
Connection point settings cannot be restored once they are deleted. Take special caution when making deletions.



## Changing the display size and inverting the image



Select the [Display] menu.

Select the image size.  
The displayed image can also be inverted.

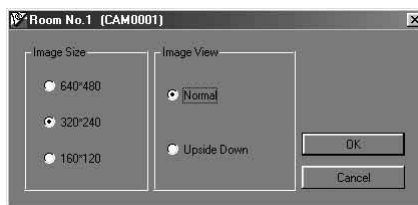

## Adjusting the image quality

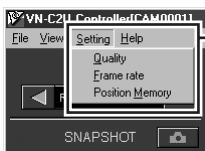

Select [Image Quality] from the [Setup] menu.

The compression ratio is inversely proportional to the image quality.  
The number of frames of the image displayed per second is proportional to the compression ratio.  
Compression ratio (Low)-(Mid)-(High)  
Image quality (High)-(Mid)-(Low)  
Number of frames (Min)-(Mid)-(Max)

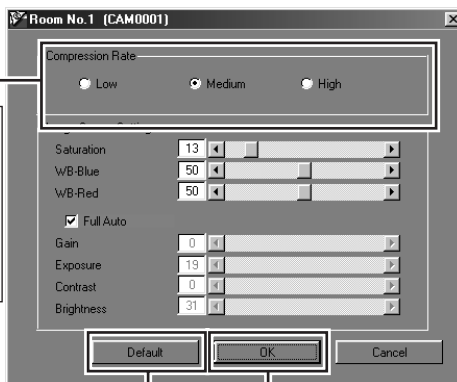

Used to set the unit to the factory settings.  
Click OK to enable settings.

To enable settings after making changes,  
click OK.

※For details on the image sensor settings, see the following page.



## Image sensor settings

The VN-C2U uses a CMOS image sensor as an imaging device.  
It is possible to adjust the image by changing the image sensor settings.

Item	Effect
Saturation	Color saturation adjustment (Saturation increases when the value is increased and the saturation decreases when the value is decreased.)
WB-Blue	Blue balance adjustment for the white balance (The color of blue will deepen when the value is increased and the color weakens when the value is decreased.)
WB-Red	Red balance adjustment for the white balance
Full Auto	Used to switch between automatic and manual (When the check is removed, the operation settings for the following 5 items will switch to manual.)
Gain	Internal amp gain adjustment (Operated only when there is shortage of light)
Exposure	Exposure time adjustment (The exposure time increases when the value is increased and the time decreases when the value is decreased.)
Contrast	Contrast adjustment
Brightness	Brightness adjustment

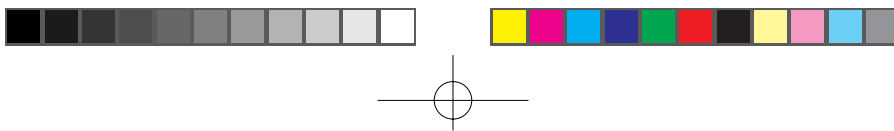

## Specifying the transmitted number of frames

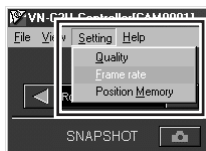

Select [Number of Frames] from the [Setup] menu.

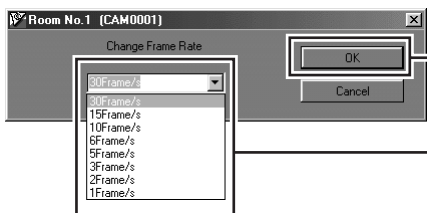

Set the upper limit of the transmitted number of frames per second for the image sent from VN-C2U.

### Notes

The actual number of frames per second transmitted or displayed is influenced by the performance of the PC, image compression ration and LAN environment. To prevent obstruction in communication to other users, please lower the frame rate when a LAN is shared by multiple processes (especially when in an environment where there is a constant heavy load on the network).

## Changing the position memory



Select [Position Memory] from the [Setup] menu.

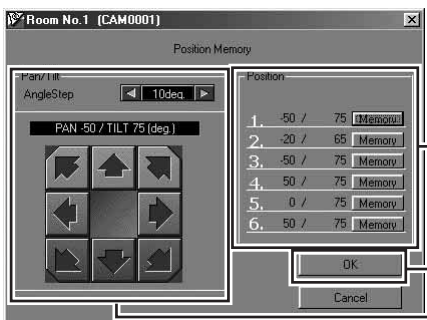

The displayed pan/tilt positions can be changed/registered by clicking Memory.

Same as the controller screen.





## Still image save feature

With the VN-C2U controller, a desired snapshot of the displayed image can be taken and saved as a JPEG image file.

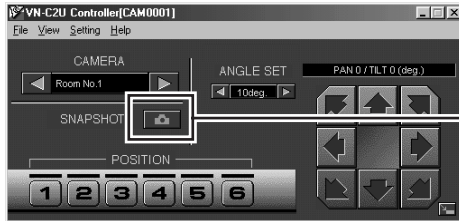

Click the Snapshot button.



The snapshot display will appear. Up to 16 snapshots can be displayed. When 16 snapshots are displayed, the camera mark will disappear. A beeping sound will be heard when clicking the Snapshot button at this time.



A file name is attached only when selecting [Save and Quit] from the [Save] menu of each snapshot display, where followed by a Save dialog box.

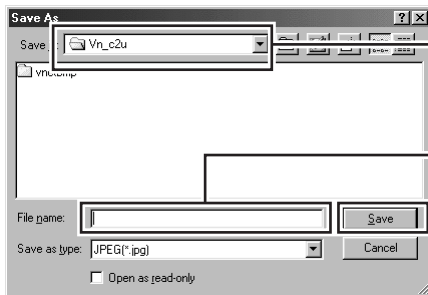

Specify the location to save.

Enter the file name.

Click Save to save the file.

### Note

Saved images can be viewed using a conventional viewer software. However, inverted images will not be displayed inverted. Furthermore, the reproduced tint may vary with the VN-C2U controller screen.

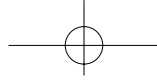

## What to do when:

<p>You forgot or misplaced the VN-C2U IP address changed using the V.NETWORKS setup tool.</p>	<p>Record of contents changed using the V.NETWORKS setup tool is saved in a file named vsetup.log located in the root directory using the following format:  IP address before change, ID before change  IP address after change, ID after change  Date/time (day/month/year/h:m)  The unit will be treated as a repair if the IP address remains unclear even after referencing the vsetup.log file. Please contact your dealer of purchase.</p>
<p>You set the password protection feature but forgot the password.</p>	<p>Cancellation of the password protection is treated as a repair. Please contact your dealer of purchase.  For security reasons, a proper identification may be requested.</p>
<p>A "Cannot control pan/tilt mechanism with the connected VN-C2U" message appears.</p>	<p>Turn off the power of VN-C2U, then turn it back on. If the symptom persists, contact your dealer of purchase.</p>
<p>It takes awhile to cancel when the "Connecting..." message is displayed.</p>	<p>Canceling of operation is purposely set so that it cannot be made for several seconds when the unit is connecting.</p>



The image is out of focus.

The focus can be adjusted by following the procedure given below.

1. Set the pan and tilt positions to  $0^{\circ}, 0^{\circ}$ .
2. Remove the lens cover.
3. Loosen the screw locking the lens block.

**Note:** For your safety, turn off the power before loosening the screw.

4. Start up the VN-C2U controller so that the VN-C2U image can be viewed.
5. Rotate the lens block slowly until the image is in focus.
6. Securely tighten the lock screw.
7. Close the lens cover (check to make sure that the notches on the lens cover and case are aligned).

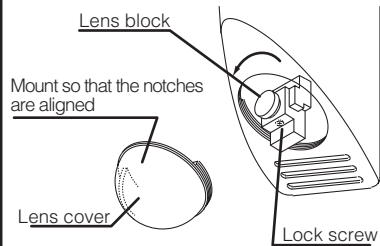

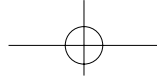

<p>When there is a problem with the tint.</p>	<p>-Check the color adjustments of the display and video card.</p> <p>The tint may vary slightly depending on the display monitor and the video card of the PC. The tint may be improved by adjusting the color setting of the monitor. Depending on the video card, the color may also be adjusted by selecting Display Properties (right click on the desktop).</p> <p>-Switch to True Color (24 bit)</p> <p>Reproduction of natural colors becomes difficult when the PC is set to High Color (16 bit) or lower. It is recommended that the PC is set to True Color.</p> <p>-Adjust WB-Red and WB-Blue</p> <p>It is also possible to adjust the tint using the WB-Red and WB-Blue in the Image quality adjustment screen.</p> <p>-Turn Full Auto off then turn it back on</p> <p>When shooting scenes with different light sources (for example alternately switching between an outdoor scene under sunlight and indoor scene under fluorescent lighting), the automatic white balance tracking may take some time to operate. In this case, check off Full Auto and check it again for immediate operation of the automatic white balance tracking.</p>
<p>The image size changed or the position shifted automatically.</p>	<p>When the same VN-C2U is connected to multiple PCs, the PC used to set or control VN-C2U last has priority over the remaining PCs.</p>



## Specifications

- LAN specification : IEEE802.3 standard
- Communication protocol : UDP/IP
- Image sensor : 1/3 inch, 300,000 pixels CMOS image sensor
- M.O.D. : 1.0 m
- Pan/Tilt angles : Pan :100°  
Tilt :80°
- Output image size : 640 X 480, 320 X 240, 160 X 120 pixels
- Line voltage : DC 5 V
- Demand current : 1.4 A (max)
- Operating temperature : 0 to 40°C
- Mass : Approx. 260 g

Dimensions (Unit: mm)

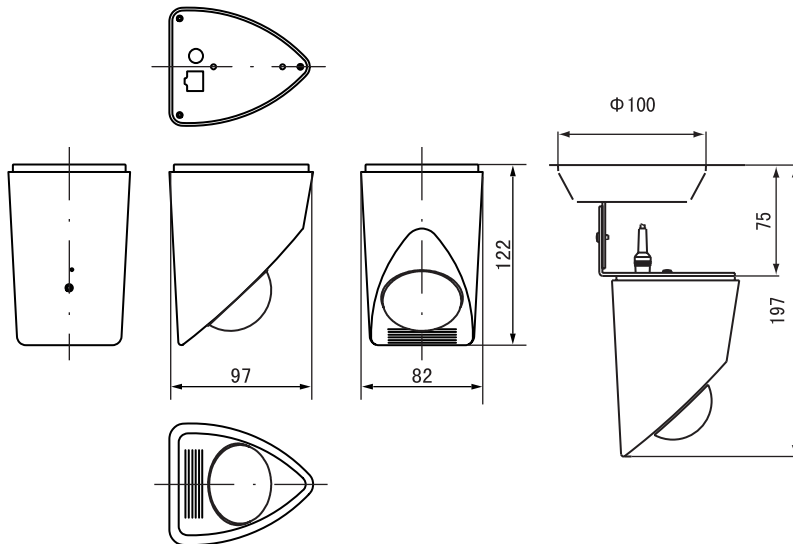

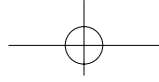
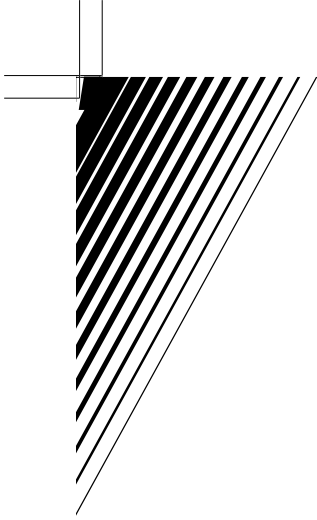

VN-C2U

V.NETWORKS

**JVC**<sup>®</sup>  
VICTOR COMPANY OF JAPAN, LIMITED

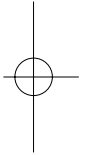
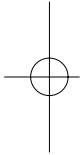

COPYRIGHT ©1999 VICTOR COMPANY OF JAPAN, LTD.

 Printed in Japan  
SS961423-002

